

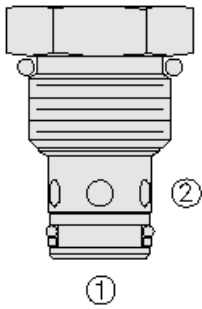

Overview

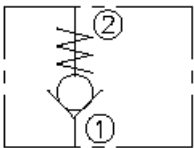

Symbol



Description

The CV10-20X is a screw-in, cartridge style, hydraulic check valve for use as a blocking or load-holding device.

Operation

The CV10-20X allows flow passage from port 1 to port 2, while normally blocking oil flow in the opposite direction. The cartridge has a fully guided check which is spring-biased closed until sufficient pressure is applied at port 1 to open to port 2.

Features

- Hardened seat for long life and low leakage.
- Optional bias springs for back-pressure application flexibility.
- 300 psi bias spring option with tall cap available.
- Fully guided check assembly.
- Industry-common cavity.

Ratings

Pressure Ratings

Pressure rating	240 bar (3500 psi)
Proof pressure	350 bar (5075 psi)

Flow Ratings

Flow rating	75.8 lpm (20 gpm)
Maximum internal leakage	2 drops/min - Note: At 240 bar (3500 psi)

Temperature Ratings

Operating fluid temperature	-40 to 100 °C (-40 to 212 °F)	- Note: With buna N seals
	-26 to 204 °C (-15 to 400 °F)	- Note: With fluorocarbon seals
	-54 to 107 °C (-65 to 225 °F)	- Note: With polyurethane seals
	-40 to 149 °C (-40 to 300 °F)	- Note: With HNBR seals
Storage temperature	-40 to 70 °C (-40 to 160 °F)	
Ambient temperature	-40 to 90 °C (-40 to 194 °F)	

Other Ratings

Corrosion protection	Gcv10-20 - 960 hour salt spray per ASTM b117
----------------------	--

Operating Parameters

Fluids	Mineral based or synthetic hydraulic fluid with lubricating properties
Fluid viscosity range	7.4 to 420 cSt
Maximum operating contamination level	20/18/14 per ISO 4406

Properties

Unit weight	0.08 kg (0.18 lb)	
	0.12 kg (0.26 lb)	- Note: "t" option
Internal wetted surface area	71 cm ² (11 in ²)	
	90 cm ² (14 in ²)	- Note: "t" option



Performance

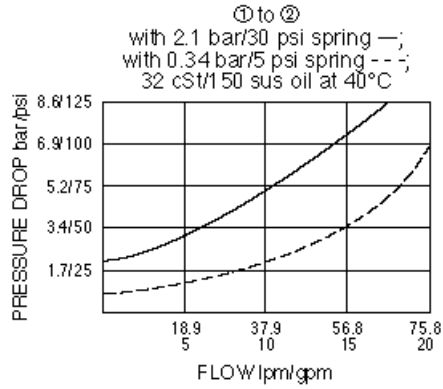
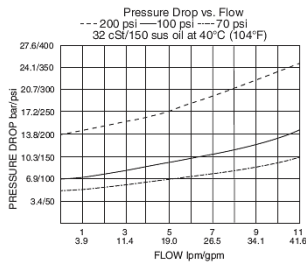
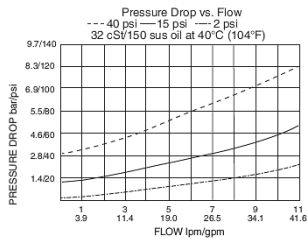

Dimensions

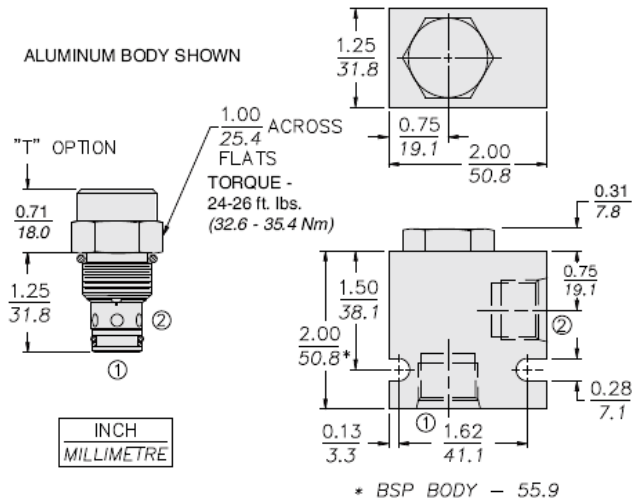

Installation Specifications

Cavity	VC10-2
Cartridge installation torque	32.6 to 35.4 N-m (24 to 26 ft-lb)
Maximum allowable torque	67.8 N-m (50 ft-lb)
Orientation restriction	None

Accessories

Seal kit SK10-2X-T - Note: X = seal option

Order Code

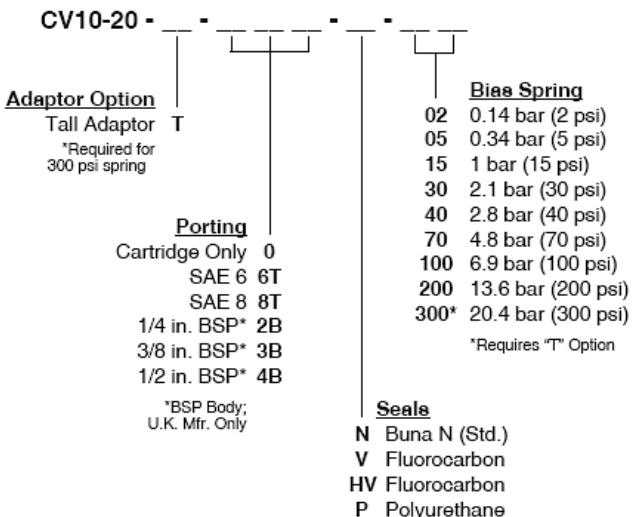



Model Options

CV10-20C-H-J-R

C Tall Cap

CODE	DESCRIPTION
BLANK	Standard Cap
T	Tall Cap

H Line Body

CODE	DESCRIPTION
0	No Body
6T	Aluminum SAE 6
8T	Aluminum SAE 8
6TD	Ductile Iron SAE 6
8TD	Ductile Iron SAE 8
2B	Aluminum BSPP 1/4" (2)
3B	Aluminum BSPP 3/8" (3)
4B	Aluminum BSPP 1/2" (4)
4BD	Ductile Iron BSPP 1/2" (4)

J Seal

CODE	DESCRIPTION
N	Buna-N
V	Fluorocarbon
P	Polyurethane
U	PPDI Urethane

R Spring

CODE	DESCRIPTION
2	2 psi Bias Spring
5	5 psi Bias Spring
15	15 psi Bias Spring
30	30 psi Bias Spring
40	40 psi Bias Spring
70	70 psi Bias Spring
100	100 psi Bias Spring
200	200 psi Bias Spring
300	300 psi Bias Spring